

CONTENTS

Products	Page	Products	Page
Displays		Refrigerated	
Free Standing Ambient Square Display	1-D	Back Bar Under Counter Refrigerators	
Free Standing Refrigerated Square Display	2-D	- Aluminium Doors	1-R
Free Standing Heated Square Display	3-D	- Stainless Steel Doors - Folded Handles	2-R
Bench Mounted Ambient Square Display	4-D	- Stainless Steel Doors - Recessed Handles	3-R
Bench Mounted Refrigerated Square Display	5-D	Glass Chillers - Single Door	4-R
Bench Mounted Heated Square Display	6-D	Glass Chillers - Double Door	5-R
Fan Forced Cold Well - Drop In	7-D		
Heated Bain Marie - Drop In	8-D	Dish Handling	
Fan Forced Cold Well	-	AT40ST Glass Washer	1-W
- Mobile Island Buffet	9-D		
Heated Bain Marie	-	Trolleys	
- Mobile Island Buffet	10-D	Tray lowerator	1-T
Fan Forced Cold Well	-		
- Chillair Mobile Island Buffet	11-D	Exhaust Canopies	
Chillair Tray Race	11-D	Condensate - Tapered Hood	1-E
		Condensate - Type 1	1-E
Ambient		Condensate - Type 2	1-E
.....		Condensate - Recirculating	1-E
.....		V Bank Hood - Type 1	1-E
		V Bank Hood - Type 1 - with Make-up Air	1-E
Heated		Box Hood - Type 1	2-E
Bain Marie - Under Bench	1-H	Box Hood - Type 1 - with Make-up Air	2-E
Mobile Bain Marie & Hot Cupboard -	-	Box Hood - Type 2	2-E
- Under Bench - RH Services	2-H	Box Hood - Type 2 - with Make-up Air	2-E
Mobile Bain Marie & Hot Cupboard -	-		
- Under Bench - LH Services	3-H	Spine and UDS Walls	
Under Bench Hot Cupboard	4-H	Free standing - No Service Risers	1-U
Mobile Bain Marie	5-H	Free standing - Single Service Riser	1-U
Mobile Bain Marie - Care Service	6-H	Free standing - Double Service Riser	1-U
Mobile Bain Marie & Hot Cupboard	7-H	Wall Mounted	2-U
Bain Marie & Bain Marie Hot Cupboard	-		
- Work Tops	8-H		
Glass Gantries - Straight	9-10-H		
2 tier Over Shelves - Single heated shelf	11-H		
2 tier Over Shelves - Dual heated shelf	11-H		
2 tier Over Shelves - Unheated shelf	11-H		
Bain Marie & Hot Cupboard Accessories	12-H		
Mobile Plate Dispensers	13-H		
Plate Dispenser Tubes & Lids	14-H		
Vertical Hot Cupboards - Half Height	15-H		
Vertical Hot Cupboards - Full Height	16-H		
Banquet Carts - Gastronorm Size	17-H		
Banquet Cart - Plates	18-H		
Banquet Cart Accessories	19-H		
Warmer Drawers	20-H		
Hot Food Slides - Flat	21-H		
Hot Food Slides - Flat	22-H		

DISPLAY LINE CABINETS - FREE STANDING

AMBIENT FOOD DISPLAY - SQUARE GLASS

- Temperature controlled ambient cabinet for displaying foods enables your food to stay fresher for longer
- Adjustable digital temperature controller allows food to be held at between 18-20°C in a maximum of 32°C air temperatures
- Double-glazed rear sliding doors - fully removable to enable easy loading and cleaning
- High impact low energy LED lighting fitted to each shelf
- Stainless steel flat shelves adjustable in height and angle with ticket stripping to the front and rear
- Removable front and rear crumb trays for ease of cleaning
- Robust construction throughout including 304 grade stainless steel body and toughened glass
- Self-contained refrigeration with built in evaporator burn-off tray (no plumbing to waste required)
- Modular design for building a display module with matching refrigerated and heated models
- Supplied with 150mm adjustable legs
- Available with glass shelves as an option (P.O.A)
- Available with rear shelf as an option (P.O.A)

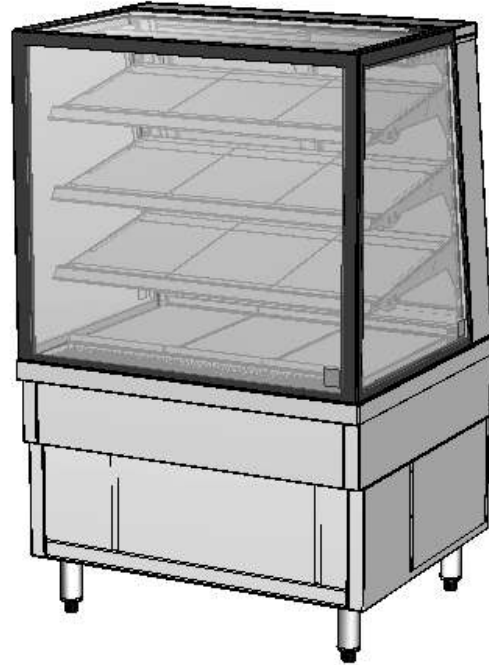

<i>Description</i>	<i>Model</i>	<i>Dimensions</i>	<i>Electrical Rating</i>	<i>RRP ex GST</i>
900mm long ambient display cabinet	CA.FD.T1.NS.L.0900	900 x 770 x 1445	1100W 4.5A 240V	\$12,675
1200mm long ambient display cabinet	CA.FD.T1.NS.L.1200	1200 x 770 x 1445	1300W 5.4A 240V	\$13,345
1500mm long ambient display cabinet	CA.FD.T1.NS.L.1500	1500 x 770 x 1445	1500W 6.25A 240V	\$14,435
1800mm long ambient display cabinet	CA.FD.T1.NS.L.1800	1800 x 770 x 1445	1750W 7.3A 240V	\$16,750

Customisation and variations on products listed above available upon request. See technical data sheet or ask your sales representative for more details. WA, NT & TAS - For orders in these states please add 5% transport surcharge to your purchase price

DISPLAY LINE CABINETS - FREE STANDING

REFRIGERATED FOOD DISPLAY - SQUARE GLASS

- Adjustable digital temperature controller allows food to be held between 2°C and 4°C in 32°C ambient air temperatures
- Features heated double-glazed glass to prevent condensation and allows excellent product display
- Double-glazed rear sliding doors - fully removable to enable easy loading and cleaning
- High impact, low energy LED lighting fitted to each shelf
- Stainless steel flat shelves adjustable in height and angle with ticket stripping to the front and rear
- Removable front and rear crumb trays for ease of cleaning
- Robust construction throughout including 304 grade stainless steel body and toughened glass
- Self-contained refrigeration with built in evaporator burn-off tray (no plumbing to waste required)
- Modular design for building a display module with matching ambient and heated models
- Supplied with 150mm adjustable legs
- Available with glass shelves as an option (P.O.A)
- Available with rear shelf as an option (P.O.A)

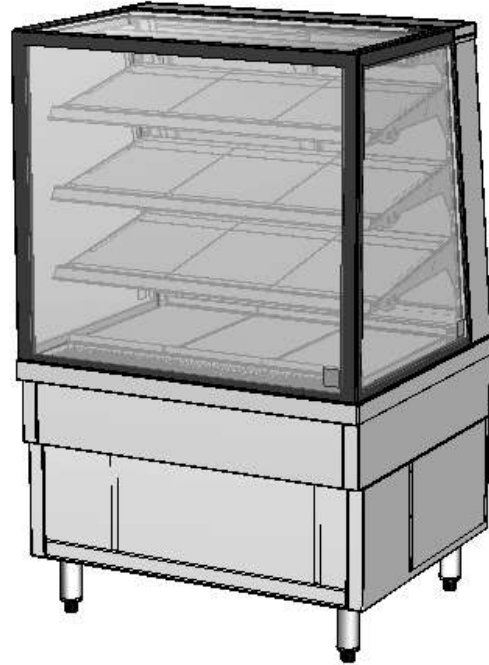

<i>Description</i>	<i>Model</i>	<i>Dimensions</i>	<i>Electrical Rating</i>	<i>RRP ex GST</i>
900mm long refrigerated display cabinet	CR.FD.T1.NS.L.0900	900 x 770 x 1445	1100W 4.5A 240V	\$12,675
1200mm long refrigerated display cabinet	CR.FD.T1.NS.L.1200	1200 x 770 x 1445	1300W 5.4A 240V	\$13,345
1500mm long refrigerated display cabinet	CR.FD.T1.NS.L.1500	1500 x 770 x 1445	1500W 6.25A 240V	\$14,435
1800mm long refrigerated display cabinet	CR.FD.T1.NS.L.1800	1800 x 770 x 1445	1750W 7.3A 240V	\$16,750

Customisation and variations on products listed above available upon request. See technical data sheet or ask your sales representative for more details. WA, NT & TAS - For orders in these states please add 5% transport surcharge to your purchase price

DISPLAY LINE CABINETS - FREE STANDING

HEATED FOOD DISPLAY - SQUARE GLASS

- Fan-forced heating provides an even temperature throughout the unit for holding pies, pastries, pizzas and other products
- Adjustable digital temperature controller allows food to be held at between 65°C and 80°C (food must be heated above 65°C before being placed in cabinet)
- Fully removable rear toughened glass sliding door with handles
- High impact lighting fitted to top shelf
- Stainless steel wire shelves adjustable in height and angle with ticket stripping to the front and rear
- Robust construction throughout including 304 grade stainless steel body and toughened glass
- Modular design for building a display module with matching refrigerated and ambient models
- Supplied with 150mm adjustable legs
- Available with rear shelf as an option (P.O.A)



<i>Description</i>	<i>Model</i>	<i>Dimensions</i>	<i>Electrical Rating</i>	<i>RRP ex GST</i>
900mm long heated display cabinet	CH.FD.T1.NS.L.0900	900 x 770 x 1445	1400W 5.8A 240V	\$8,950
1200mm long heated display cabinet	CH.FD.T1.NS.L.1200	1200 x 770 x 1445	2600W 10.8A 240V	\$10,040
1500mm long heated display cabinet	CH.FD.T1.NS.L.1500	1500 x 770 x 1445	3800W 15.8A 240V	\$11,450
1800mm long heated display cabinet	CH.FD.T1.NS.L.1800	1800 x 770 x 1445	5000W 20.8A 240V	\$13,560

Customisation and variations on products listed above available upon request. See technical data sheet or ask your sales representative for more details. WA, NT & TAS - For orders in these states please add 5% transport surcharge to your purchase price

DISPLAY LINE CABINETS - BENCH MOUNTED

AMBIENT FOOD DISPLAY - SQUARE GLASS

- Temperature controlled ambient cabinet for displaying foods allows your food to stay fresher for longer
- Adjustable digital temperature controller allows food to be held at between 18-20°C in 32°C air temperatures
- Double-glazed rear sliding doors - fully removable to enable easy loading and cleaning
- High impact low energy LED lighting fitted to each shelf
- Stainless steel flat shelves adjustable in height and angle with ticket stripping to the front and rear
- Removable front and rear crumb trays for ease of cleaning
- Robust construction throughout including 304 grade stainless steel body and toughened glass
- Self-contained refrigeration with built in evaporator burn-off tray (no plumbing to waste required)
- Display is able to be recessed into the counter for a stunning low profile effect
- Modular design for building a display module with matching refrigerated and heated models
- Available with glass shelves as an option



<i>Description</i>	<i>Model</i>	<i>Dimensions</i>	<i>Electrical Rating</i>	<i>RRP ex GST</i>
900 wide ambient food display	CA.FD.T2.0900	900 x 760 x 1245	1100W 4.5A 240V	\$12,345
1200 wide ambient food display	CA.FD.T2.1200	1200 x 760 x 1245	1300W 5.4A 240V	\$13,015
1500 wide ambient food display	CA.FD.T2.1500	1500 x 760 x 1245	1500W 6.25A 240V	\$14,060
1800 wide ambient food display	CA.FD.T2.1800	1800 x 760 x 1245	1750W 7.3A 240V	\$16,315

Customisation and variations on products listed above available upon request. See technical data sheet or ask your sales representative for more details. WA, NT & TAS - For orders in these states please add 5% transport surcharge to your purchase price

DISPLAY LINE CABINETS - BENCH MOUNTED

REFRIGERATED FOOD DISPLAY - SQUARE GLASS

- Adjustable digital temperature controller allows food to be held at between 2°C and 4°C in 32°C air temperatures
- Features heated double-glazed glass to prevent condensation and allows excellent product display
- Double-glazed rear sliding doors - fully removable to enable easy loading and cleaning
- High impact, low energy LED lighting fitted to each shelf
- Stainless steel flat shelves adjustable in height and angle with ticket stripping to the front and rear
- Removable front and rear crumb trays for ease of cleaning
- Robust construction throughout including 304 grade stainless steel body and toughened glass
- Self-contained refrigeration with built in evaporator burn-off tray (no plumbing to waste required)
- Display is able to be recessed into the counter for a stunning low profile effect
- Modular design for building a display module with matching ambient and heated models
- Available with glass shelves as an option



<i>Description</i>	<i>Model</i>	<i>Dimensions</i>	<i>Electrical Rating</i>	<i>RRP ex GST</i>
900 wide refrigerated food display	CR.FD.T2.0900	900 x 760 x 1245	1100W 4.5A 240V	\$12,345
1200 wide refrigerated food display	CR.FD.T2.1200	1200 x 760 x 1245	1300W 5.4A 240V	\$13,015
1500 wide refrigerated food display	CR.FD.T2.1500	1500 x 760 x 1245	1500W 6.25A 240V	\$14,060
1800 wide refrigerated food display	CR.FD.T2.1800	1800 x 760 x 1245	1750W 7.3A 240V	\$16,315

Customisation and variations on products listed above available upon request. See technical data sheet or ask your sales representative for more details. WA, NT & TAS - For orders in these states please add 5% transport surcharge to your purchase price

DISPLAY LINE CABINETS - BENCH MOUNTED

HEATED FOOD DISPLAY - SQUARE GLASS

- Static heating elements provides an even temperature throughout the unit for holding pies, pastries, pizzas and other products
- Adjustable digital temperature controller allows food to be held at between 65°C and 80°C (food must be heated above 65°C before being placed in cabinet)
- Rear toughened glass sliding door with handles - fully removable to enable easy loading and cleaning
- Stainless steel wire shelves adjustable in height and angle with ticket stripping to the front and rear
- Robust construction throughout including 304 grade stainless steel body and toughened glass
- Display is able to be recessed into the counter for a stunning low profile effect
- Modular design for building a display module with matching refrigerated and ambient models
- Various accessories available



<i>Description</i>	<i>Model</i>	<i>Dimensions</i>	<i>Electrical Rating</i>	<i>RRP ex GST</i>
900 wide heated food display	CH.FD.T2.0900	900 x 760 x 840	1400W 5.8A 240V	\$5,180
1200 wide heated food display	CH.FD.T2.1200	1200 x 760 x 840	2600W 10.8A 240V	\$5,667
1500 wide heated food display	CH.FD.T2.1500	1500 x 760 x 840	3800W 15.8A 240V	\$6,640
1800 wide heated food display	CH.FD.T2.1800	1800 x 760 x 840	4400W 18.3A 240V	\$7,290

Customisation and variations on products listed above available upon request. See technical data sheet or ask your sales representative for more details. WA, NT & TAS - For orders in these states please add 5% transport surcharge to your purchase price

BUFFET LINE COLD WELLS - SELF CONTAINED

DROP-IN FAN FORCED COLD WELL WITH GANTRY

- Designed to hold products at precise temperatures between 2°C and 4°C in 32°C ambient temperatures
- Fitted with a stainless steel gantry support frame and light surround
- 10mm toughened flat glass gantry or 8mm toughened curved glass gantry fitted with overhead fluorescent lights
- Takes gastronorm pans up to 100mm deep (Sold separately)
- On/Off switches to operate cold well and overhead Gantry light
- Digital temperature controller for accurate and easy to read display
- Self-contained refrigeration condensate is to be collected container under the unit as standard, or can be plumbed to waste
- Complete 304 grade stainless steel construction

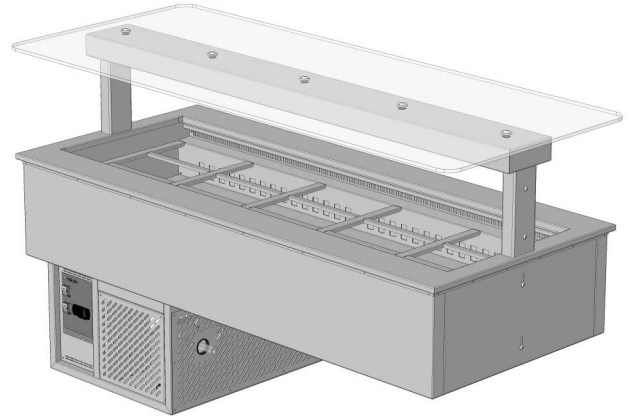

Drop-in

T1A = Flat Glass

<i>Description</i>	<i>Model</i>	<i>Dimensions</i>	<i>Electrical Rating</i>	<i>RRP ex GST</i>
3 Gastronorm pan capacity cold well	CR.CWFFG.T1A.3M	1195 x 822 x 1080	808W 3.4A 240V	\$9,925
4 Gastronorm pan capacity cold well	CR.CWFFG.T1A.4M	1535 x 822 x 1080	746W 3.1A 240V	\$11,615
5 Gastronorm pan capacity cold well	CR.CWFFG.T1A.5M	1875 x 822 x 1080	918W 3.8A 240V	\$12,865
6 Gastronorm pan capacity cold well	CR.CWFFG.T1A.6M	2215 x 822 x 1080	840W 3.5A 240V	\$13,820
7 Gastronorm pan capacity cold well	CR.CWFFG.T1A.7M	2555 x 822 x 1080	1176W 4.9A 240V	\$15,215
8 Gastronorm pan capacity cold well	CR.CWFFG.T1A.8M	2895 x 822 x 1080	1192W 5A 240V	\$16,475

Customisation and variations on products listed above available upon request. See technical data sheet or ask your sales representative for more details. WA, NT & TAS - For orders in these states please add 5% transport surcharge to your purchase price

BUFFET LINE BAIN MARIES

HEATED BAIN MARIE WITH GANTRY

- Modular drop-in design allows for simple, inexpensive installation
- Takes gastronorm pans (max. 150mm deep, sold separately) that are designed to be recessed to minimise water condensation on surrounding bench tops
- Adjustable temperature controller allows food to be held at between 65°C and 80°C
- Fitted with 10mm thick toughened glass gantry with overhead quartz IR heat lamps to maintain surface temperature and provide product illumination
- Overhead heat lamps are fully adjustable via a solid-state voltage controller for accurate temperature selection
- Electro-mechanical temperature controls are fitted to ensure long term reliable service
- Individual On/Off switches to operate bain marie and overhead gantry heat lamps
- Robust construction throughout with 304 grade stainless steel and toughened glass



Drop-in

T1A = Flat Glass

<i>Description</i>	<i>Model</i>	<i>Dimensions</i>	<i>Electrical Rating</i>	<i>RRP ex GST</i>
3 Gastronorm pan capacity bain marie	CH.BMG.T1A.3M	1195 x 822 x 830	2850W 3Ø 4.4A 240V	\$6,720
4 Gastronorm pan capacity bain marie	CH.BMG.T1A.4M	1535 x 822 x 830	3900W 3Ø 6.25A 240V	\$7,295
5 Gastronorm pan capacity bain marie	CH.BMG.T1A.5M	1875 x 822 x 830	4950W 3Ø 6.25A 240V	\$8,190
6 Gastronorm pan capacity bain marie	CH.BMG.T1.6M	2215 x 822 x 830	5700W 3Ø 9.37A 240V	\$9,020
7 Gastronorm pan capacity bain marie	CH.BMG.T1.7M	2555 x 822 x 830	6750W 3Ø 9.4A 240V	\$9,815
8 Gastronorm pan capacity bain marie	CH.BMG.T1.8M	2895 x 822 x 830	8000W 3Ø 12.5A 240V	\$10,600

Customisation and variations on products listed above available upon request. See technical data sheet or ask your sales representative for more details. WA, NT & TAS - For orders in these states please add 5% transport surcharge to your purchase price

ISLAND BUFFETS -MOBILE

FAN FORCED COLD WELL ISLAND BUFFET

- Designed to hold products at precise temperatures between 2°C and 4°C in 32°C ambient temperatures
- Fitted with a stainless steel gantry support frame and light surround
- 10mm toughened glass overhead gantry fitted with overhead fluorescent lights
- Takes gastronorm pans up to 100mm deep (Sold separately)
- On/Off switches to operate cold well and overhead Gantry light
- Digital temperature controller for accurate and easy to read display
- Self-contained refrigeration (supplies with removable condensate collection container as standard or can be plumbed to waste)
- Vents are fitted to the cupboard to enable the refrigeration unit to function correctly
- Ability to customise length and width to suit application - minimum possible dimensions shown



T1A = Flat Glass

Description	Model	Minimum Dimensions	Electrical Rating	RRP ex GST
3 Gastronorm pan capacity cold well	CR.IB.T1A.3M	1380 x 1000 x 1280	808W 3.4A 240V	\$13,860
4 Gastronorm pan capacity cold well	CR.IB.T1A.4M	1720 x 1000 x 1280	746W 3.1A 240V	\$14,765
5 Gastronorm pan capacity cold well	CR.IB.T1A.5M	2060 x 1000 x 1280	918W 3.8A 240V	\$16,370
6 Gastronorm pan capacity cold well	CR.IB.T1A.6M	2400 x 1000 x 1280	840W 3.5A 240V	\$17,345
7 Gastronorm pan capacity cold well	CR.IB.T1A.7M	2740 x 1000 x 1280	1176W 4.9A 240V	\$18,890
8 Gastronorm pan capacity cold well	CR.IB.T1A.8M	3080 x 1000 x 1280	1192W 5A 240V	\$20,210

Customisation and variations on products listed above available upon request. See technical data sheet or ask your sales representative for more details. WA, NT & TAS - For orders in these states please add 5% transport surcharge to your purchase price

ISLAND BUFFETS -MOBILE

HEATED BAIN MARIE ISLAND BUFFET

- Gastronorm pans (max.150mm deep, sold separately) are designed to be recessed to minimise water condensation on surrounding bench tops
- Adjustable temperature controller allows food to be held at between 65°C and 80°C
- Fitted with 10mm thick toughened glass gantry with overhead quartz IR heat lamps to maintain surface temperature and provide product illumination
- Overhead heat lamps are fully adjustable via a solid-state voltage controller for accurate temperature selection
- Electro-mechanical temperature controls are fitted to ensure long term reliable service
- Individual On/Off switches to operate bain marie and gantry heat lamps
- 32mm Laminated top and 16mm pre-finished board to carcass and doors to match customers decor (available in a selected range of colours and finishes)
- Ability to customise length and width to suit application - minimum possible dimensions shown



T1A = Flat Glass

Description	Model	Minimum Dimensions	Electrical Rating	RRP ex GST
3 Gastronorm pan capacity bain marie	CH.IB.T1A.3M	1380 x 1000 x 1280	2850W 3Ø 4.38A 240V	\$11,290
4 Gastronorm pan capacity bain marie	CH.IB.T1A.4M	1720 x 1000 x 1280	2900W 3Ø 6.25A 240V	\$12,290
5 Gastronorm pan capacity bain marie	CH.IB.T1A.5M	2060 x 1000 x 1280	4950W 3Ø 6.25A 240V	\$13,265
6 Gastronorm pan capacity bain marie	CH.IB.T1A.6M	2400 x 1000 x 1280	5700W 3Ø 9.37A 240V	\$14,490
7 Gastronorm pan capacity bain marie	CH.IB.T1A.7M	2740 x 1000 x 1280	6750W 3Ø 9.37A 240V	\$15,470
8 Gastronorm pan capacity bain marie	CH.IB.T1A.8M	3080 x 1000 x 1280	8000W 3Ø 12.5A 240V	\$16,695

Customisation and variations on products listed above available upon request. See technical data sheet or ask your sales representative for more details. WA, NT & TAS - For orders in these states please add 5% transport surcharge to your purchase price

CHILLAIR - HIGH PERFORMANCE

CHILLAIR ISLAND BUFFET

- A practical and attractive solution to the presentation and storage of food for self-serve and in crib situations
- Full-length fan-forced refrigeration system mounted to the base of the cold well
- Designed to hold products at temperatures between 1°C and 5°C in 35°C ambient temperatures
- Fitted with a heavy-duty stainless steel gantry support frame and light surround
- 10mm perspex gantry fitted with overhead fluorescent lights
- Takes gastronorm pans up to 100mm deep
- Robust On/Off switches to operate cold well and overhead gantry lights
- Digital temperature controller for accurate and easy-to-read display
- Self-contained refrigeration with removable bucket for condensate (No plumbing to waste required)
- Complete 304 stainless steel construction
- Optional removable tray race is also available (sold separately)
- Supplied with stainless steel covers for the cold well
- Supplied on heavy-duty castors

chillair



Description	Model	Dimensions	Electrical Rating	RRP ex GST
6 Gastronorm pan capacity island buffet	CR.IB.CLCBF6	2140 x 754 x 1535	1440W 6A 240V	\$14,995
8 Gastronorm pan capacity island buffet	CR.IB.CLCBF8	2810 x 754 x 1535	1560W 9.5A 240V	\$15,750

TRAY RACE

- The removable tray race adds additional flexibility to the CHILLAIR buffet unit
- Two sections are required per side to provide a full-length tray race

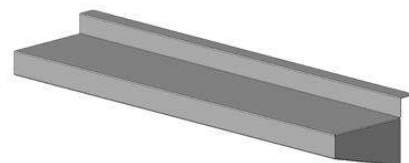

6 Module tray race 4 per unit as standard	CR.IB.CLCBF6.TR			\$320 each
8 Module tray race 4 per unit as standard	CR.IB.CLCBF8.TR			\$340 each

Customisation and variations on products listed above available upon request. See technical data sheet or ask your sales representative for more details. WA, NT & TAS - For orders in these states please add 5% transport surcharge to your purchase price

BAIN MARIES

UNDER BENCH BAIN MARIE

- Heavy duty bain marie designed to hold hot food at the optimum temperature in GN pans up to 150mm deep
- Double skinned construction, air insulated on all sides to minimise heat of external panels
- Ready for connection to hot water inlet and waste with all valves supplied
- Semi automatic fill design with pre-fitted overflow stand pipe as standard
- Fully modular system designed to fit under custom made stainless steel bench top
- Complete 304 grade stainless steel construction
- Available in 2, 3, 4, 5, 6, 7, & 8 GN 1/1 modules

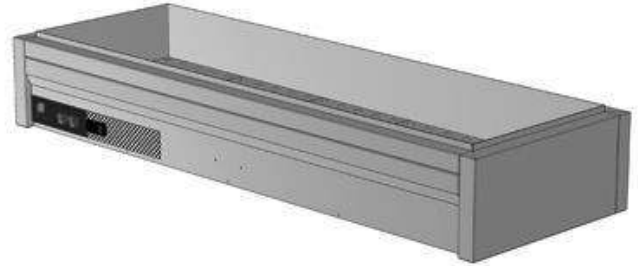

NOTE: Work top required when adding gantry to unit.
 Addition of gantry will change electrical requirements. See your local Stoddart representative for more information.

Description	Model	Dimensions	Electrical Rating	RRP ex GST
2 module under bench bain marie	CH.CBM2.U	760 x 610 x 285	1500W	\$2,580
	with radius corners CH.CBM2.UR	760 x 610 x 285	6.25A 240V	\$2,980
3 module under bench bain marie	CH.CBM3.U	1100 x 610 x 285	2250W	\$2,880
	with radius corners CH.CBM3.UR	1100 x 610 x 285	9.37A 240V	\$3,220
4 module under bench bain marie	CH.CBM4.U	1440 x 610 x 285	3000W	\$3,080
	with radius corners CH.CBM4.UR	1440 x 610 x 285	12.5A 240V	\$3,420
5 module under bench bain marie	CH.CBM5.U	1780 x 610 x 285	3750W	\$3,280
	with radius corners CH.CBM5.UR	1780 x 610 x 285	3 ⓪ 6.25A 240V	\$3,620
6 module under bench bain marie	CH.CBM6.U	2120 x 610 x 285	4500W	\$3,620
	with radius corners CH.CBM6.UR	2120 x 610 x 285	3 ⓪ 6.25A 240V	\$4,040
7 module under bench bain marie	CH.CBM7.U	2460 x 610 x 285	5250W	\$3,980
	with radius corners CH.CBM7.UR	2460 x 610 x 285	3 ⓪ 9.37A 240V	\$4,360
8 module under bench bain marie	CH.CBM8.U	2800 x 610 x 285	6000W	\$4,480
	with radius corners CH.CBM8.UR	2800 x 610 x 285	3 ⓪ 9.37A 240V	\$4,840

Customisation and variations on products listed above available upon request. See technical data sheet or ask your sales representative for more details. WA, NT & TAS - For orders in these states please add 5% transport surcharge to your purchase price

BAIN MARIE & HOT-CUPBOARD

UNDER BENCH BAIN MARIE AND HOT CUPBOARD - RIGHT HAND CONTROLS

- Heavy duty bain marie designed to hold hot food at the optimum temperature in GN pans up to 150mm deep
- Separately controlled hot cupboard features a fan forced heating system, which offers energy saving efficiency, faster heat-up times and even heat distribution
- Adjustable temperature controller allows food to be held at between 65°C and 90°C
- Easy glide doors that do not sit in a track, eliminates dirt trap
- Fully modular system designed to fit under custom made stainless steel bench top
- Double skinned construction, air insulated on all sides to minimise heat of external panels
- Ready for connection to hot water inlet and waste with all valves supplied
- Semi automatic fill design with pre-fitted overflow stand pipe as standard
- Complete 304 grade stainless steel construction
- Available in 3, 4, 5, 6, 7, & 8 GN 1/1 module
- Supplied with 1 chrome plated steel wire shelf per door

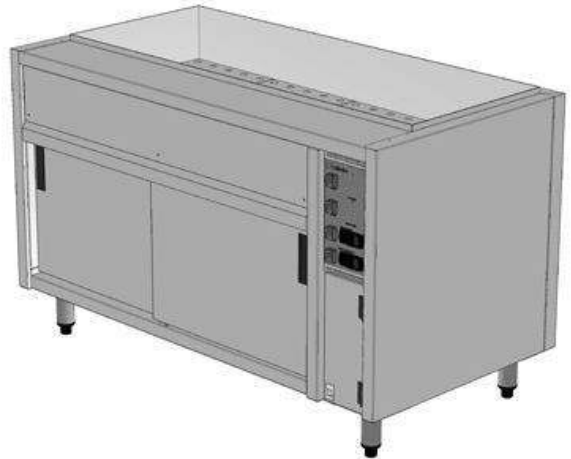

NOTE: Work top required when adding gantry to unit. Addition of gantry will change electrical requirements. See your local Stoddart representative for more information.

Description	Model	Dimensions	Electrical Rating	RRP ex GST
3 Gastronorm pan capacity bain marie and hot cupboard	CH.CBMH3.U	1100 x 750 x 900	4500W	\$5,340
	with radius corners CH.CBMH3.UR	1100 x 750 x 900	3Ø 9.38A 240V	\$5,740
4 Gastronorm pan capacity bain marie and hot cupboard	CH.CBMH4.U	1440 x 750 x 900	5250W	\$5,980
	with radius corners CH.CBMH4.UR	1440 x 750 x 900	3Ø 9.38A 240V	\$6,380
5 Gastronorm pan capacity bain marie and hot cupboard	CH.CBMH5.U	1780 x 750 x 900	6000W	\$6,520
	with radius corners CH.CBMH5.UR	1780 x 750 x 900	3Ø 9.38A 240V	\$6,960
6 Gastronorm pan capacity bain marie and hot cupboard	CH.CBMH6.U	2120 x 750 x 900	6750W	\$7,060
	with radius corners CH.CBMH6.UR	2120 x 750 x 900	3Ø 9.58A 240V	\$7,480
7 Gastronorm pan capacity bain marie and hot cupboard	CH.CBMH7.U	2460 x 750 x 900	9,750W	\$8,720
	with radius corners CH.CBMH7.UR	2460 x 750 x 900	3Ø 15.6A 240V	\$9,120
8 Gastronorm pan capacity bain marie and hot cupboard	CH.CBMH8.U	2800 x 750 x 900	10,500W	\$9,120
	with radius corners CH.CBMH8.UR	2800 x 750 x 900	3Ø 15.6A 240V	\$9,540

Customisation and variations on products listed above available upon request. See technical data sheet or ask your sales representative for more details. WA, NT & TAS - For orders in these states please add 5% transport surcharge to your purchase price

BAIN MARIE & HOT-CUPBOARD

UNDER BENCH BAIN MARIE AND HOT CUPBOARD - LEFT HAND CONTROLS

- Heavy duty bain marie designed to hold hot food at the optimum temperature in GN pans up to 150mm deep
- Separately controlled hot cupboard features a fan forced heating system, which offers energy saving efficiency, faster heat-up times and even heat distribution
- Adjustable temperature controller allows food to be held at between 65°C and 90°C
- Easy glide doors that do not sit in a track, eliminates dirt trap
- Fully modular system designed to fit under custom made stainless steel bench top
- Double skinned construction, air insulated on all sides to minimise heat of external panels
- Ready for connection to hot water inlet and waste with all valves supplied and fitted.
- Auto fill design with pre-fitted overflow stand pipe as standard
- Complete 304 grade stainless steel construction
- Available in 3, 4, 5, 6, 7, & 8 GN 1/1 module
- Supplied with 1 chrome plated steel wire shelf per door

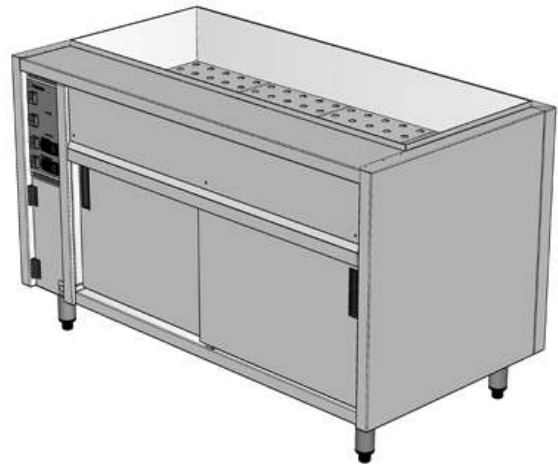

NOTE: Work top required when adding gantry to unit. Addition of gantry will change electrical requirements. See your local Stoddart representative for more information.

Description	Model	Dimensions	Electrical Rating	RRP ex GST
3 Gastronorm pan capacity bain marie and hot cupboard	CH.CBMH3.U.LH	1100 x 750 x 900	4500W	\$5,760
	with radius corners CH.CBMH3.UR.LH	1100 x 750 x 900	3Ø 9.38A 240V	\$6,160
4 Gastronorm pan capacity bain marie and hot cupboard	CH.CBMH4.U.LH	1440 x 750 x 900	5250W	\$6,380
	with radius corners CH.CBMH4.UR.LH	1440 x 750 x 900	3Ø 9.38A 240V	\$6,820
5 Gastronorm pan capacity bain marie and hot cupboard	CH.CBMH5.U.LH	1780 x 750 x 900	6000W	\$6,960
	with radius corners CH.CBMH5.UR.LH	1780 x 750 x 900	3Ø 9.38A 240V	\$7,360
6 Gastronorm pan capacity bain marie and hot cupboard	CH.CBMH6.U.LH	2120 x 750 x 900	6750W	\$7,480
	with radius corners CH.CBMH6.UR.LH	2120 x 750 x 900	3Ø 9.58A 240V	\$7,880
7 Gastronorm pan capacity bain marie and hot cupboard	CH.CBMH7.U.LH	2460 x 750 x 900	9,750W	\$9,120
	with radius corners CH.CBMH7.UR.LH	2460 x 750 x 900	3Ø 15.6A 240V	\$9,540
8 Gastronorm pan capacity bain marie and hot cupboard	CH.CBMH8.U.LH	2800 x 750 x 900	10,500W	\$9,540
	with radius corners CH.CBMH8.UR.LH	2800 x 750 x 900	3Ø 15.6A 240V	\$9,960

Customisation and variations on products listed above available upon request. See technical data sheet or ask your sales representative for more details. WA, NT & TAS - For orders in these states please add 5% transport surcharge to your purchase price

UNDER BENCH HOT CUPBOARDS

UNDER BENCH HOT CUPBOARD

- Designed to heat plates and serving dishes, capable of holding plated meals and bulk foods
- Features a fan forced heating system, for gentle and even distribution of heat
- Adjustable thermostat with digital temperature display can adjust temperature up to 90°C
- Easy glide doors that do not sit in a track - eliminates dirt trap
- Fully modular system designed to fit under custom made stainless steel bench top
- Double skinned construction, air insulated on all sides to minimise heat of external panels
- Complete 304 grade stainless steel construction
- Available in 3, 4, 5, 6, 7, & 8 GN 1/1 module
- Supplied with 1 chrome plated steel wire shelf per door



NOTE: Designed for under bench use as standard - add a work top for use as a preparation bench (sold separately)

<i>Description</i>	<i>Model</i>	<i>Dimensions</i>	<i>Electrical Rating</i>	<i>RRP ex GST</i>
3 module hot cupboard	CH.CHC3.U	1100 x 650 x 870	2250W 9.38A 240V	\$3,680
4 module hot cupboard	CH.CHC4.U	1440 x 650 x 870	2250W 9.38A 240V	\$3,960
5 module hot cupboard	CH.CHC5.U	1780 x 650 x 870	2250W 9.38A 240V	\$4,640
6 module hot cupboard	CH.CHC6.U	2120 x 650 x 870	2250W 9.38A 240V	\$5,020
7 module hot cupboard	CH.CHC7.U	2460 x 650 x 870	4500W 18.75A 240V	\$5,860
8 module hot cupboard	CH.CHC8.U	2800 x 650 x 870	4500W 18.75A 240V	\$6,280

Customisation and variations on products listed above available upon request. See technical data sheet or ask your sales representative for more details. WA, NT & TAS - For orders in these states please add 5% transport surcharge to your purchase price

MOBILE BAIN MARIE

MOBILE BAIN MARIE

- Mobile heavy duty bain marie designed to hold hot food at the optimum temperature in GN pans up to 150mm deep
- Digital controller allows temperature adjustments between 30°C and 90°C
- Ergonomic stainless steel handle for easy mobility of the unit
- Double skinned construction, air insulated on all sides to minimise heat of external panels
- Manual fill and manual empty
- Removable element covers
- Heavy duty non marking 125mm castors with brakes
- Complete 304 grade stainless steel construction
- Standard gantries are available with or without heat lamps; glass sides; roller doors; sneeze guards. Lift up, fold down side shelf.



NOTE: Addition of gantry will change electrical requirements. See your local Stoddart representative for more information.

<i>Description</i>	<i>Model</i>	<i>Dimensions</i>	<i>Electrical Rating</i>	<i>RRP ex GST</i>
3 module mobile bain marie	CH.CBM3.M	1210 x 645 x 900	1800W 7.5 A 240V	\$3,780
4 module mobile bain marie	CH.CBM4.M	1550 x 645 x 900	2400W 10A 240V	\$4,320

Customisation and variations on products listed above available upon request. See technical data sheet or ask your sales representative for more details. WA, NT & TAS - For orders in these states please add 5% transport surcharge to your purchase price

MOBILE BAIN MARIE

MOBILE BAIN MARIE - CARE SERVICE

- Mobile heavy duty bain marie designed to hold hot food at the optimum temperature in GN pans up to 65mm deep
- Energy regulator allows temperature adjustments between 30°C and 120°C
- Ergonomic stainless steel handle for easy mobility of the unit
- Double skinned construction, air insulated on all sides to minimise heat of external panels
- Dry operation only to Bain Marie
- Heavy duty non marking 125mm castors with brakes
- Complete 304 grade stainless steel construction
- A slide out plastic tub is supplied for rubbish or utensils
- Perforated light-weight mid shelf provides extra storage
- A retractable 495mm wide 285mm deep stainless steel serving shelf



NOTE: As standard, the Bain Marie is not supplied with the Cambro MPC300 insulated cupboard, but this item can be ordered as an optional extra.

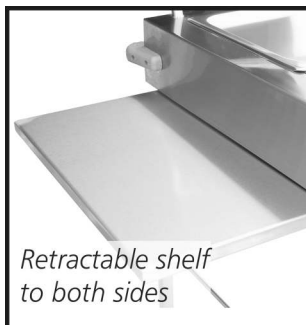

Description	Model	Dimensions	Electrical Rating	RRP ex GST
3 module mobile care service bain marie	CH.CBM3.M.CS	1115 x 645 x 900	680W 2.8A 240V	\$5,950
4 module mobile care service bain marie	CH.CBM4.M.CS	1419 x 645 x 900	1020W 4.25A 240V	\$6,490

Customisation and variations on products listed above available upon request. See technical data sheet or ask your sales representative for more details. WA, NT & TAS - For orders in these states please add 5% transport surcharge to your purchase price

MOBILE BAIN MARIES & HOT CUPBOARD

MOBILE BAIN MARIE AND HOT CUPBOARD

- Mobile heavy duty bain marie designed to hold hot food at the optimum temperature in GN pans up to 150mm deep
- Separately controlled hot cupboard features a fan forced heating system, which offers energy saving efficiency, faster heat-up times and even heat distribution
- Adjustable individual thermostat with digital temperature display can adjust temperature up to 90°C
- Ergonomic stainless steel handle for easy mobility of the unit
- Double skinned construction, air insulated on all sides to minimise heat of external panels
- Removable element covers
- Heavy duty non marking 125mm castors with brakes
- Easy glide doors that do not sit in a track - eliminates dirt trap
- Complete 304 grade stainless steel construction
- Supplied with 1 chrome plated steel wire shelf per door
- Standard gantries are available with or without heat lamps; glass sides; roller doors; sneeze guards. Lift up, fold down side shelf.



<i>Description</i>	<i>Model</i>	<i>Dimensions</i>	<i>Electrical Rating</i>	<i>RRP ex GST</i>
3 gastronorm pan capacity mobile bain marie and hot cupboard	CH.CBMH3.M	1210 x 680 x 900	3350W 14A 240V	\$5,960
4 gastronorm pan capacity mobile bain marie and hot cupboard	CH.CBMH4.M	1550 x 680 x 900	4700W 19.6A 240V	\$6,480

Customisation and variations on products listed above available upon request. See technical data sheet or ask your sales representative for more details. WA, NT & TAS - For orders in these states please add 5% transport surcharge to your purchase price

BAIN MARIE ACCESSORIES

BAIN MARIE WORK TOPS

- 304 Stainless steel worktop in no. 4 finish
- Plywood backed
- Includes divider bars for GN well
- For CH.CBM series

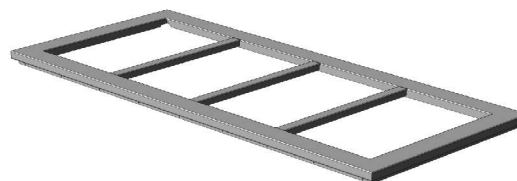

Description	Model	Dimensions	RRP ex GST
2 module - Drop-in kit	CH.CTBM.2D	797 x 647 x 40	\$520
3 module - Drop-in kit	CH.CTBM.3D	1137 x 647 x 40	\$540
4 module - Drop-in kit	CH.CTBM.4D	1477 x 647 x 40	\$560
5 module - Drop-in kit	CH.CTBM.5D	1817 x 647 x 40	\$640
6 module - Drop-in kit	CH.CTBM.6D	2157 x 647 x 40	\$680
7 module - Drop-in kit	CH.CTBM.7D	2497 x 647 x 40	\$720
8 module - Drop-in kit	CH.CTBM.8D	2837 x 647 x 40	\$780

BAIN MARIE HOT-CUPBOARD WORK TOPS

- 304 Stainless steel worktop in no. 4 finish
- Plywood backed
- Includes divider bars
- For CH.CBMH.U series

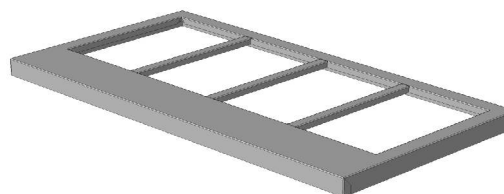

Description	Model	Dimensions	RRP ex GST
3 module - Island top	CH.CT.3i	1104 x 754 x 56	\$540
4 module - Island top	CH.CT.4i	1444 x 754 x 56	\$580
5 module - Island top	CH.CT.5i	1784 x 754 x 56	\$660
6 module - Island top	CH.CT.6i	2124 x 754 x 56	\$720
7 module - Island top	CH.CT.7i	2464 x 754 x 56	\$780
8 module - Island top	CH.CT.8i	2804 x 754 x 56	\$840

BAIN MARIE HOT-CUPBOARD WORK TOPS

- 304 Stainless steel worktop in no. 4 finish
- Plywood backed
- Includes divider bars
- For CH.CHC.U series

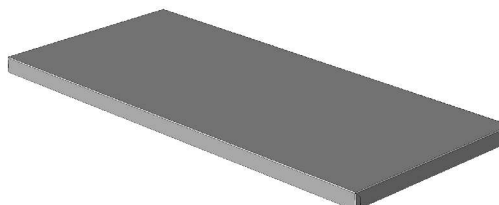

Description	Model	Dimensions	RRP ex GST
3 module - Island top	CH.CTHC.3	1104 x 654 x 56	\$530
4 module - Island top	CH.CTHC.4	1444 x 654 x 56	\$580
5 module - Island top	CH.CTHC.5	1784 x 654 x 56	\$650
6 module - Island top	CH.CTHC.6	2124 x 654 x 56	\$710
7 module - Island top	CH.CTHC.7	2464 x 654 x 56	\$760
8 module - Island top	CH.CTHC.8	2804 x 654 x 56	\$830

BAIN MARIE ACCESSORIES

GANTRIES - STRAIGHT GLASS

- To be fitted to customizable bain maries
- Stainless steel top in no. 4 finish
- Stainless steel tubes (32 x 32mm)
- 6mm toughened glass to ends
- Single glazed sliding toughened glass door available as an additional option
- Price includes fitting to Culinaire bain marie top
- Heated models include overhead infra-red heat lamps

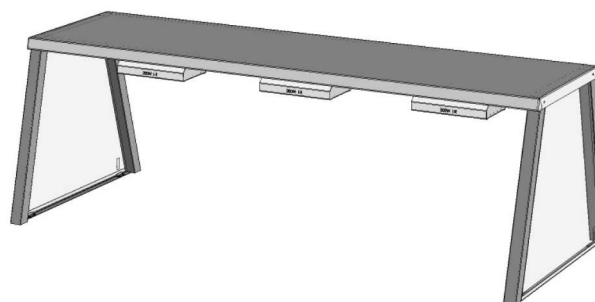

Unheated A frame gantry with glass ends only

Description	Model	Dimensions	RRP ex GST
Suits 3 bay model	CH.CG.3G	1080 x 600 x 475	\$580
Suits 4 bay model	CH.CG.4G	1420 x 600 x 475	\$650
Suits 5 bay model	CH.CG.5G	1760 x 600 x 475	\$720
Suits 6 bay model	CH.CG.6G	2100 x 600 x 475	\$760
Suits 7 bay model	CH.CG.7G	2440 x 600 x 475	\$830
Suits 8 bay model	CH.CG.8G	2780 x 600 x 475	\$910

Heated A frame gantry with glass ends only

Description	Model	Dimensions	Electrical Rating (all 240V)	RRP ex GST
Suits 3 bay model - 2 heat lamps	CH.CG.3GH	1080 x 600 x 475	600W, 2.5A	\$920
Suits 4 bay model - 3 heat lamps	CH.CG.4GH	1420 x 600 x 475	900W, 3.75A	\$1,030
Suits 5 bay model - 4 heat lamps	CH.CG.5GH	1760 x 600 x 475	1200W, 5A	\$1,160
Suits 6 bay model - 4 heat lamps	CH.CG.6GH	2100 x 600 x 475	1200W, 5A	\$1,220
Suits 7 bay model - 5 heat lamps	CH.CG.7GH	2440 x 600 x 475	1500W, 6.25A	\$1,400
Suits 8 bay model - 6 heat lamps	CH.CG.8GH	2780 x 600 x 475	1500W, 6.25A	\$1,540

Fixed glass front

Description	Model	Dimensions	RRP ex GST
Suits 3 bay A frame gantry	CH.CGF.3G	1080 x 300 x 750	\$120
Suits 4 bay A frame gantry	CH.CGF.4G	1420 x 300 x 750	\$130
Suits 5 bay A frame gantry	CH.CGF.5G	1760 x 300 x 750	\$140
Suits 6 bay A frame gantry	CH.CGF.6G	2100 x 300 x 750	\$150
Suits 7 bay A frame gantry	CH.CGF.7G	2440 x 300 x 750	\$160
Suits 8 bay A frame gantry	CH.CGF.8G	2780 x 300 x 750	\$180

For combined electrical loads including gantries as well as pricing, contact your local sales representative. Customisation and variations on products listed above available upon request. See technical data sheet or ask your sales representative for more details.
 WA, NT & TAS - For orders in these states please add 5% transport surcharge to your purchase price

BAIN MARIE ACCESSORIES

GANTRIES - STRAIGHT GLASS OPTION

- To be fitted to customizable bain maries
- 6mm clear glass to ends
- Single glazed sliding toughened glass door to rear available as an additional option
- Price includes fitting to Culinaire bain marie top

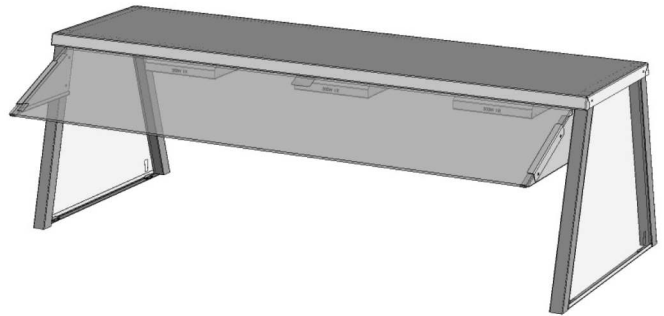

Sliding glass door (per side)

Description	Model	Dimensions	RRP ex GST
Suits 3 bay model - 2 doors	CH.CGD.3G	1080 x 600 x 475	\$240
Suits 4 bay model - 2 doors	CH.CGD.4G	1420 x 600 x 475	\$260
Suits 5 bay model - 2 doors	CH.CGD.5G	1760 x 600 x 475	\$300
Suits 6 bay model - 3 doors	CH.CGD.6G	2100 x 600 x 475	\$340
Suits 7 bay model - 4 doors	CH.CGD.7G	2440 x 600 x 475	\$360
Suits 8 bay model - 4 doors	CH.CGD.8G	2780 x 600 x 475	\$400

Glass sneeze guards (per side)

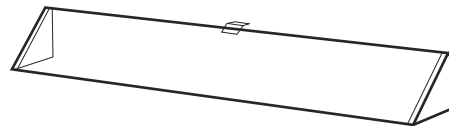

Description	Model	Dimensions	RRP ex GST
Suits 3 bay A frame gantry	CH.CSG.3G	1080 x 600 x 475	\$150
Suits 4 bay A frame gantry	CH.CSG.4G	1420 x 600 x 475	\$160
Suits 5 bay A frame gantry	CH.CSG.5G	1760 x 600 x 475	\$170
Suits 6 bay A frame gantry	CH.CSG.6G	2100 x 600 x 475	\$180
Suits 7 bay A frame gantry	CH.CSG.7G	2440 x 600 x 475	\$260
Suits 8 bay A frame gantry	CH.CSG.8G	2780 x 600 x 475	\$280

NOTE: To fit a gantry to a Culinaire bain marie (CH.CBM series) or bain marie hot-cupboard (CH.CBMH.U series) you will also need a suitable work-top or a custom top supplied by others

Lexan (heat resistant plastic) gantries also available. For combined electrical loads including gantries as well as pricing, contact your local sales representative. Customisation and variations on products listed above available upon request. See technical data sheet or ask your sales representative for more details. WA, NT & TAS - For orders in these states please add 5% transport surcharge to your purchase price

BAIN MARIE ACCESSORIES

OVER SHELVES - HEATED & UNHEATED

- Fully fitted shelves that can be fitted over bain maries, refrigerated wells or ambient bench tops
- Heated shelf models are fitted with infra-red heat lamps
- Heated shelves are ideal for meal pick up areas
- Stainless steel posts (32 x 32mm)
- Complete stainless steel construction
- Not for general individual installation - must be installed on bain marie surface

NOTE: Specify top or bottom shelf when ordering single heated shelf

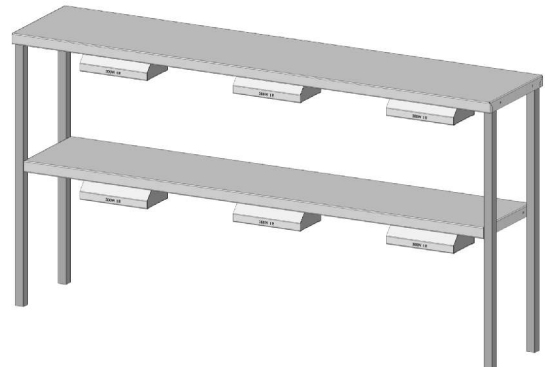

2 tier Over Shelves - Single heated shelf

Description	Model	Dimensions	Electrical Rating (all 240V)	RRP ex GST
Suits 3 bay model - 2 heat lamps	CH.CDG.3HS	1080 x 300 x 750	600W, 2.5A	\$880
Suits 4 bay model - 3 heat lamps	CH.CDG.4HS	1420 x 300 x 750	900W, 3.75A	\$1,040
Suits 5 bay model - 4 heat lamps	CH.CDG.5HS	1760 x 300 x 750	1200W, 5A	\$1,120
Suits 6 bay model - 4 heat lamps	CH.CDG.6HS	2100 x 300 x 750	1200W, 5A	\$1,180
Suits 7 bay model - 5 heat lamps	CH.CDG.7HS	2440 x 300 x 750	1500W, 6.25A	\$1,480
Suits 8 bay model - 6 heat lamps	CH.CDG.8HS	2780 x 300 x 750	1800W, 7.5A	\$1,520

2 tier Over Shelves - Dual heated shelves

Description	Model	Dimensions	Electrical Rating (all 240V)	RRP ex GST
Suits 3 bay model* - 2 heat lamps per shelf	CH.CDG.3H	1080 x 300 x 750	1200W, 5A	\$980
Suits 4 bay model* - 3 heat lamps per shelf	CH.CDG.4H	1420 x 300 x 750	1800W, 7.5A	\$1,120
Suits 5 bay model - 4 heat lamps per shelf	CH.CDG.5H	1760 x 300 x 750	2400W, 10A	\$1,320
Suits 6 bay model - 4 heat lamps per shelf	CH.CDG.6H	2100 x 300 x 750	2400W, 10A	\$1,380
Suits 7 bay model - 5 heat lamps per shelf	CH.CDG.7H	2440 x 300 x 750	3000W, 12.5A	\$1,620
Suits 8 bay model - 6 heat lamps per shelf	CH.CDG.8H	2780 x 300 x 750	3600W, 15A	\$1,680

*Cannot be fitted to CBMHx.M units as current drain will be over 20 Amp

2 tier Over Shelves - Unheated shelves

Description	Model	Dimensions	RRP ex GST
Suits 3 bay model	CH.CDG.3	1080 x 300 x 750	\$690
Suits 4 bay model	CH.CDG.4	1420 x 300 x 750	\$720
Suits 5 bay model	CH.CDG.5	1760 x 300 x 750	\$820
Suits 6 bay model	CH.CDG.6	2100 x 300 x 750	\$940
Suits 7 bay model	CH.CDG.7	2440 x 300 x 750	\$1,090
Suits 8 bay model	CH.CDG.8	2780 x 300 x 750	\$1,220

NOTE: To fit a gantry to a Culinaire bain marie (CH.CBM series) or bain marie hot-cupboard (CH.CBMH.U series) you will also need a suitable work-top or a custom top supplied by others.
 Customisation and variations on products listed above available upon request. See technical data sheet or ask your sales representative for more details.

BAIN MARIE & HOT CUPBOARD ACCESSORIES

WORK SHELF

- Lift-up removable shelf to side of unit
- Designed for heavy duty commercial use
- Complete stainless steel construction in no. 4 finish

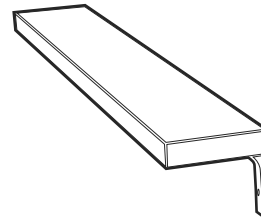

Description	Model	Dimensions	RRP ex GST
Suits 3 bay model	CH.CWS.3	1100 x 250	\$460
Suits 4 bay model	CH.CWS.4	1440 x 250	\$500
Suits 5 bay model	CH.CWS.5	1780 x 250	\$560
Suits 6 bay model	CH.CWS.6	2120 x 250	\$620
Suits 7 bay model	CH.CWS.7	2460 x 250	\$640
Suits 8 bay model	CH.CWS.8	2800 x 250	\$660

PAN/CROSS BAR DIVIDERS

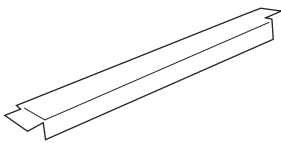

- To suit Culinaire bain maries
- Stainless steel construction

Description	Model	RRP ex GST
Large pan dividers	CH.CPD.L	\$20
Cross bar dividers	CH.CPD.C	\$16

BAIN MARIE HOTCUPBOARD & UNDERCOUNTER HOTCUPBOARD SHELVES

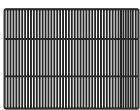

- Additional shelves for bain marie hotcupboards and undercounter hotcupboards
- Suits CH.CBMH and CH.CHC ranges
- Chrome plated steel construction

Requirements for a full set of shelves



Model	Racks required per model			
	Part ID	Qty	Part ID	Qty
CH.CBMH3.M	CMGE.0415	2		
CH.CBMH3.U	CMGE.0418	2		
CH.CBMH4.M	CMGE.0416	2		
CH.CBMH4.U	CMGE.0419	2		
CH.CBMH5.U	CMGE.0418	1	CMGE.0419	2
CH.CBMH6.U	CMGE.0420	3		
CH.CBMH7.U	CMGE.0418	2	CMGE.0419	2
CH.CBMH8.U	CMGE.0419	4		
CH.CHC3.U	CMGE.0415	2		
CH.CHC4.U	CMGE.0416	2		
CH.CHC5.U	CMGE.0415	1	CMGE.0416	2
CH.CHC6.U	CMGE.0417	3		
CH.CHC7.U	CMGE.0415	2	CMGE.0416	2
CH.CHC8.U	CMGE.0416	4		

Model	Dimensions	RRP ex GST
CMGE.0415	500 x 385	\$40
CMGE.0416	500 x 550	\$52
CMGE.0417	500 x 600	\$56
CMGE.0418	600 x 385	\$48
CMGE.0419	600 x 550	\$58
CMGE.0420	600 x 600	\$62

MOBILE PLATE DISPENSER

MOBILE PLATE DISPENSER

- Fully mobile plate dispenser
- Fan forced heat (dual tube only), static heat, or ambient models available
- Heated models come with double walled carcass
- Fitted with either 1 or 2 x 75kg capacity adjustable plate dispensing tubes that suit 260-310mm plates
- Thermostatically controlled elements with digital controller
- Complete 304 stainless steel construction
- Supplied with heavy duty 125mm castors with brakes
- Lids sold separately

	<i>Description</i>	<i>Model</i>	<i>Dimensions & Electrical Rating</i>	<i>RRP ex GST</i>
	Single tube static heated mobile plate dispenser	CH.CPD1.HS	565 x 655 x 960 600W 2.5A 240V	\$3,840
	Single tube ambient mobile plate dispenser	CH.CPD1.A	565 x 655 x 960	\$3,260
	Dual tube fan forced heated mobile plate dispenser	CH.CPD2.HF	565 x 1075 x 960 2200W 9.2A 240V	\$4,920
	Dual tube static heated mobile plate dispenser	CH.CPD2.HS	565 x 1075 x 960 2200W 9.2A 240V	\$4,380
	Dual tube ambient mobile plate dispenser	CH.CPD2.A	565 x 1075 x 960	\$3,980

Customisation and variations on products listed above available upon request. See technical data sheet or ask your sales representative for more details. WA, NT & TAS - For orders in these states please add 5% transport surcharge to your purchase price

MOBILE PLATE DISPENSER

PLATE DISPENSER TUBES - AMBIENT & HEATED

- Heated and ambient plate dispenser tubes
- Suits 260-310mm plates and 290-338mm plates
- Drop-in to bench cut-out
- Ambient - open configuration
- Heated - includes full stainless steel shroud and 10 amp plug and lead



CPTU.310 CPTH.310

<i>Description</i>	<i>Model</i>	<i>Dimensions</i>	<i>RRP ex GST</i>
Ambient models	CMGE.0574	400 x 400 x 760 <i>Suits plates 260-310mm</i>	\$830
	CMGE.0576	450 x 450 x 760 <i>Suits plates 290-338mm</i>	\$935
Heated models	CMGE.0947	382 x 382 x 730 <i>Suits plates 210-285mm</i>	\$1,565
	CMGE.0575	400 x 400 x 760 <i>Suits plates 260-310mm</i>	\$1,585
	CMGE.0577	450 x 450 x 760 <i>Suits plates 290-338mm</i>	\$1,665

PLATE DISPENSER TUBES LIDS

- Grey polycarbonate lid to suit 310 & 340 series plate dispenser tubes



<i>Description</i>	<i>Model</i>	<i>Dimensions</i>	<i>RRP ex GST</i>
Tube lids	CMGE.0578	Suits 310 & 340mm diameter	\$90

Customisation and variations on products listed above available upon request. See technical data sheet or ask your sales representative for more details. WA, NT & TAS - For orders in these states please add 5% transport surcharge to your purchase price

VERTICAL HOT CUPBOARDS

VERTICAL HOT CUPBOARD - 2/1 GASTRONORM HALF HEIGHT UNITS

- Designed for the storage of pre-cooked food in covered G/N pans
- Designed as a storage cabinet to transport pre-heated food
- Solid element in base provides heating source
- Excellent long term food holding capacity
- Easy-to-use and highly reliable mechanical temperature controls
- On / Off switch with indicator light
- Thermostatically controlled elements
- Double skinned construction insulation on all sides
- Magnetic catch and snap lock handle to ensure firm door closure
- Self-closing hinges on all doors
- Horizontal transport handle for effortless manoeuvrability of the cart
- Fully adjustable slides for different size pans
- Complete 304 grade stainless steel construction (no mild steel used)
- Supplied with 4 x 2/1 GN sized racks

<i>Description</i>	<i>Model</i>	<i>Dimensions</i>	<i>Electrical Rating</i>	<i>RRP ex GST</i>
Half height 2/1 gastronorm static heating hot cupboard	CH.VHCM.2-1.HH.S	695 x 855 x 1080	1500W 6.25A 240V	\$3,785
Half height 2/1 gastronorm static heating glass door hot cupboard	CH.VHCM.2-1.HHG.S	695 x 855 x 1080	1500W 6.25A 240V	\$3,890



VERTICAL HOT CUPBOARDS

VERTICAL HOT CUPBOARD - 2/1 GASTRONORM FULL HEIGHT UNITS

- Designed for the storage of pre-cooked food in covered G/N pans
- Designed as a storage cabinet to transport pre-heated food
- Solid element in base provides heating source
- Excellent long term food holding capacity
- Easy-to-use and highly reliable mechanical temperature controls
- On / Off switch with indicator light
- Thermostatically controlled elements
- Double skinned construction insulation on all sides
- Magnetic catch and snap lock handle to ensure firm door closure
- Self-closing hinges on all doors
- Horizontal transport handle for effortless manoeuvrability of the cart
- Fully adjustable slides for different size pans
- Complete 304 grade stainless steel construction (no mild steel used)
- Supplied with 7 x 2/1 GN sized racks



<i>Description</i>	<i>Model</i>	<i>Dimensions</i>	<i>Electrical Rating</i>	<i>RRP ex GST</i>
Full height 2/1 gastronorm static heating hot cupboard	CH.VHCM.2-1.FH.S	695 x 855 x 1815	2250W 9.37A 240V	\$4,660
Full height 2/1 gastronorm static heating 2 door hot cupboard	CH.VHCM.2-1.FH.2D.S	695 x 855 x 1815	2250W 9.37A 240V	\$5,220
Full height 2/1 gastronorm static heating glass door hot cupboard	CH.VHCM.2-1.FHG.S	695 x 855 x 1815	2250W 9.37A 240V	\$5,285
Full height 2/1 gastronorm static heating 2 glass door hot cupboard	CH.VHCM.2-1.FH2G.S	695 x 855 x 1815	2250W 9.37A 240V	\$5,320

Customisation and variations on products listed above available upon request. See technical data sheet or ask your sales representative for more details. WA, NT & TAS - For orders in these states please add 5% transport surcharge to your purchase price

BANQUET CARTS

BANQUET CARTS GASTRONORM SIZE

- Designed for the storage of pre-cooked food in pans, or plated meals
- Ideal for banquet situations or for extra kitchen heated storage
- Unique heater blanket system evenly and gently keeps the food warm
- Unique heater blanket system promotes minimal moisture loss in product due to motionless heat
- Excellent long term food holding capacity
- Easy to slide Crisp/Moist slot to control humidity
- Easy-to-use digital display, preset to 85°C from factory
- On / Off switch with indicator light
- Double skinned construction insulation on all sides
- Magnetic catch and snap lock handle to ensure firm door closure
- Self-closing hinges on all doors
- Horizontal transport handle for effortless manoeuvrability of the cart
- Fully adjustable slides for different size pans
- Complete 304 grade stainless steel construction (no mild steel used)
- Supplied on sturdy 125mm easy-to-push lockable castors



<i>Description</i>	<i>Model</i>	<i>Dimensions & Electrical Rating</i>	<i>RRP ex GST</i>
Single door gastronorm undercounter banquet cart Capacity - 12 x 1/1 GN or 6 x 2/1 GN pans 65mm deep Includes 6 sets of tray/rack slides & 4 chrome plated shelves	CH.CBC.1211	945 x 780 x 830 840W 3.5A 240V	\$5,860



Single door gastronorm compact banquet cart Capacity - 20 x 1/1 GN or 10 x 2/1 GN pans 65mm deep Includes 10 sets of tray/rack slides & 4 chrome plated shelves	CH.CBC.2011	945 x 795 x 1345 1680W 7A 240V	\$6,520
--	-------------	---	---------



Single door gastronorm banquet cart Capacity - 26 x 1/1 GN or 13 x 2/1 GN pans 65mm deep Includes 13 sets of tray/rack slides & 4 chrome plated shelves	CH.CBC.2611	945 x 795 x 1635 1680W 7A 240V	\$7,220
--	-------------	---	---------

Customisation and variations on products listed above available upon request. See technical data sheet or ask your sales representative for more details. WA, NT & TAS - For orders in these states please add 5% transport surcharge to your purchase price

BANQUET CARTS

BANQUET CARTS - PLATES

- Designed for the storage of pre-cooked food in pans, or plated meals
- Ideal for banquet situations or for extra kitchen heated storage
- Unique heater blanket system evenly and gently keeps the food warm
- Unique heater blanket system promotes minimal moisture loss in product due to motionless heat
- Excellent long term food holding capacity
- Easy to slide Crisp/Moist slot to control humidity
- Easy-to-use digital display, preset to 85°C from factory
- On / Off switch with indicator light
- Double skinned construction insulation on all sides
- Magnetic catch and snap lock handle to ensure firm door closure
- Self-closing hinges on all doors
- Horizontal transport handle for effortless manoeuvrability of the cart
- Fully adjustable slides for different size pans
- Complete 304 grade stainless steel construction (no mild steel used)
- Supplied on sturdy 125mm easy-to-push lockable castors



Description	Model	Dimensions & Electrical Rating	RRP ex GST
Double door 96 plate banquet cart		1110 x 780 x 1815	
Capacity - 96 x 10" (254mm) plates using plate holders	CH.CBC.96	1680W 7A 240V	\$7,960
Includes 4 x tray/rack slides & 4 x chrome plated shelves			



Double door 128 plate banquet cart		1310 x 780 x 1815	
Capacity - 128 x 10" (254mm) plates using plate holders	CH.CBC.128	2020W 8.41A 240V	\$8,820
Includes 4 x tray/rack slides & 4 x chrome plated shelves			

TOTAL CAPACITY FOR ABOVE UNITS:
Using Plate Carriers (refer to page 18-H)



CH.CBC96	24 X CPC8-10C - 96 pre-plated meals 16 x CPC10-12C - 64 pre-plated meals
CH.CBC128	32 X CPC8-10C - 128 pre-plated meals 24 x CPC10-12C - 96 pre-plated meals

Customisation and variations on products listed above available upon request. See technical data sheet or ask your sales representative for more details. WA, NT & TAS - For orders in these states please add 5% transport surcharge to your purchase price

BANQUET CART ACCESSORIES

TRAY SLIDES - PER PAIR



<i>Description</i>	<i>Model</i>	<i>RRP ex GST</i>
Tray slides - to suit CH.CBC2611, 2011, 1211, 96 & 128	CH.CTS	\$34

CHROME PLATED WIRE PLATE CARRIERS



<i>Description</i>	<i>Model</i>	<i>Dimensions</i>	<i>RRP ex GST</i>
Chrome plated plate carriers (hold 4 pre-plated meals. 67mm vertical rung spacing)			
8" to 9" diameter plate carrier	CMGE.0980	255 x 240 x 295	\$88



10" to 11" diameter plate carrier	CMGE.0979	300 x 240 x 300	\$98
-----------------------------------	-----------	-----------------	------

STAINLESS STEEL WIRE GASTRONORM RACKS

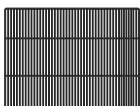

2/1 to suit CH.CBC.2611 & CH.CBC .2011	CMGE.926	530 x 650	\$88
--	----------	-----------	------

1/1 to suit CH.CBC.2611 & CH.CBC.2011	CMGE.927	530 x 325	\$68
---------------------------------------	----------	-----------	------

CHROME WIRE GASTRONORM RACKS

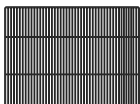

2/1 to suit CH.CBC.2611 & CH.CBC.2011	CMGE.0421	530 x 650	\$36
---------------------------------------	-----------	-----------	------

CHROME WIRE RACKS (for plating models)

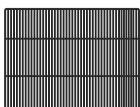

To suit CH.CBC.96	CMGE.0422	610 x 690	\$88
To suit CH.CBC.128	CMGE.0013	906 x 612	\$118

OTHER PRODUCTS

WARMER DRAWERS

- Uses unique heater blanket system to evenly and gently heat the food being kept in drawers
- Holds one 1/1 GN pan per drawer
- Complete 304 stainless steel construction



<i>Description</i>	<i>Model</i>	<i>Dimensions</i>	<i>Electrical Rating</i>	<i>RRP ex GST</i>
2 warming drawers 1/1	CH.CWD2.1/1	615 x 630 x 520	1120W 4.75A 240V	\$3,860
2 warming drawers 1/1 with independent timer and notification lights	CH.CWD2.N	615 x 630 x 520	1120W 4.75A 240V	\$4,800

Customisation and variations on products listed above available upon request. See technical data sheet or ask your sales representative for more details. WA, NT & TAS - For orders in these states please add 5% transport surcharge to your purchase price

HOT FOOD SLIDE

FLAT HOT FOOD SLIDE

- Ideal for canteens and self serve food sales outlets for keeping pre-cooked and packaged food warm
- Overhead heat lamps above the front of each shelf to keep product warm and illuminated for customers
- Two additional overhead stainless steel elements per shelf to ensure even heat of all products from front to back
- Base slides heated with specially engineered heater pads to ensure a warm and even heat distribution without burn-spots
- 8mm diameter heavy-duty stainless steel product divider bars, adjustable in 20mm increments, can fit foods of all sizes and are removable for easy cleaning
- Individual heat controls for each shelf and heavy-duty on/off switches
- Durable on-off switches operate the overhead lighting for each shelf
- Heavy duty construction in 1.2mm 304 grade stainless steel

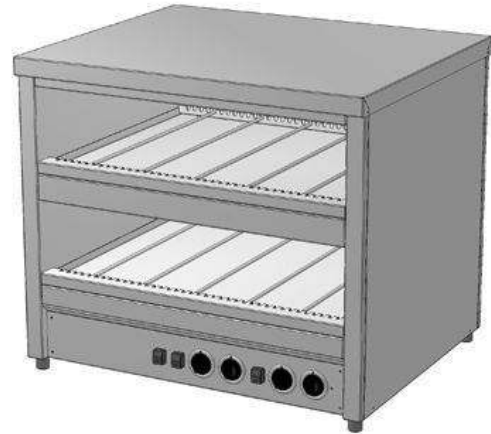

Single slide model

<i>Description</i>	<i>Model</i>	<i>Dimensions</i>	<i>Electrical Rating</i>	<i>RRP ex GST</i>
900 wide unit	CH.HFS.F.1.900	900 x 750 x 483	2310W 9.7A 240V	\$5,820
1200 wide unit	CH.HFS.F.1.1200	1200 x 750 x 483	3400W 14.2A 240V	\$6,010
1500 wide unit	CH.HFS.F.1.1500	1500 x 750 x 483	4350W 18.2A 240V	\$6,550

Dual slide model

<i>Description</i>	<i>Model</i>	<i>Dimensions</i>	<i>Electrical Rating</i>	<i>RRP ex GST</i>
900 wide unit	CH.HFS.F.2.900	900 x 750 x 762	4620W 3Ø 9.7A 240V	\$8,280
1200 wide unit	CH.HFS.F.2.1200	1200 x 750 x 762	6800W 3Ø 15A 240V	\$8,590
1500 wide unit	CH.HFS.F.2.1500	1500 x 750 x 762	8700W 3Ø 20A 240V	\$8,930

Customisation and variations on products listed above available upon request. See technical data sheet or ask your sales representative for more details. WA, NT & TAS - For orders in these states please add 5% transport surcharge to your purchase price

HOT FOOD SLIDE

ANGLED HOT FOOD SLIDE

- Ideal for canteens and self serve food sales outlets for keeping pre-cooked and packaged food warm
- Overhead heat lamps above the front of each shelf to keep product warm and illuminated for customers
- Two additional overhead stainless steel elements per shelf to ensure even heat of all products from front to back
- Base slides heated with specially engineered heater pads to ensure a warm and even heat distribution without burn-spots
- 8mm diameter heavy-duty stainless steel product divider bars, adjustable in 20mm increments, can fit foods of all sizes and are removable for easy cleaning
- Individual heat controls for each shelf and heavy-duty on/off switches
- Durable on-off switches operate the overhead lighting for each shelf
- Heavy duty construction in 1.2mm 304 grade stainless steel



Single slide model

Description	Model	Dimensions	Electrical Rating	RRP ex GST
900 wide unit	CH.HFS.A.1.900	900 x 750 x 483	2310W 9.7A 240V	\$5,820
1200 wide unit	CH.HFS.A.1.1200	1200 x 750 x 483	3400W 14.2A 240V	\$6,010
1500 wide unit	CH.HFS.A.1.1500	1500 x 750 x 483	4350W 18.2 240V	\$6,550

Dual slide model

Description	Model	Dimensions	Electrical Rating	RRP ex GST
900 wide unit	CH.HFS.A.2.900	900 x 750 x 762	4620W 3Ø 9.7 240V	\$8,280
1200 wide unit	CH.HFS.A.2.1200	1200 x 750 x 762	6800W 3Ø 15A 240V	\$8,590
1500 wide unit	CH.HFS.A.2.1500	1500 x 750 x 762	8700W 3Ø 20A 240V	\$8,930

Customisation and variations on products listed above available upon request. See technical data sheet or ask your sales representative for more details. WA, NT & TAS - For orders in these states please add 5% transport surcharge to your purchase price

BACKBAR UNDER COUNTER DRINK CABINETS - REMOTE

BACK BAR REFRIGERATOR - ALUMINIUM FRAME DOORS

- Keeps contents at a cool 1°C in 32°C ambient temperatures
- Ensures maximum product visibility with interior vertical LED lighting
- Aluminium framed low energy double glazed, heated and toughened glass doors are self-closing and self-sealing to ensure ease of operation & improved efficiency
- Available in 2-7 doors to suit every application
- Left hand hinged doors as standard
- Choice of either stainless steel or black internal and external finishes as standard
- Supplied with 4 adjustable shelves per door

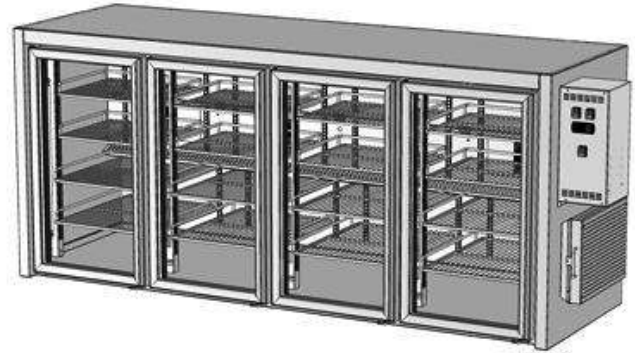

Stainless steel finish models

Description	Model	Dimensions	Electrical Rating	RRP ex GST
2 door model	CR.BB.UC2.T1.A.R.SSA.L.2	1450 x 700 x 960	300W, 1.2A 240V	\$9,215
3 door model	CR.BB.UC3.T1.A.R.SSA.L.2	1970 x 700 x 960	430W, 1.8A 240V	\$11,735
4 door model	CR.BB.UC4.T1.A.R.SSA.L.2	2490 x 700 x 960	576W, 2.4A 240V	\$14,200
5 door model	CR.BB.UC5.T1.A.R.SSA.L.2	3010 x 700 x 960	720W, 3A 240V	\$16,580
6 door model	CR.BB.UC6.T1.A.R.SSA.L.2	3530 x 700 x 960	865W, 3.6A 240V	\$19,040
7 door model	CR.BB.UC7.T1.A.R.SSA.L.2	4050 x 700 x 960	1010W, 4.2A 240V	\$21,370

Black finish models

Description	Model	Dimensions	Electrical Rating	RRP ex GST
2 door model	CR.BB.UC2.T1.A.R.BBB.L.2	1450 x 700 x 960	300W, 1.2A 240V	\$9,245
3 door model	CR.BB.UC3.T1.A.R.BBB.L.2	1970 x 700 x 960	430W, 1.8A 240V	\$11,800
4 door model	CR.BB.UC4.T1.A.R.BBB.L.2	2490 x 700 x 960	576W, 2.4A 240V	\$14,305
5 door model	CR.BB.UC5.T1.A.R.BBB.L.2	3010 x 700 x 960	720W, 3A 240V	\$16,725
6 door model	CR.BB.UC6.T1.A.R.BBB.L.2	3530 x 700 x 960	865W, 3.6A 240V	\$19,230
7 door model	CR.BB.UC7.T1.A.R.BBB.L.2	4050 x 700 x 960	1010W, 4.2A 240V	\$21,590

Customisation and variations on products listed above available upon request. See technical data sheet or ask your sales representative for more details. WA, NT & TAS - For orders in these states please add 5% transport surcharge to your purchase price

BACKBAR UNDER COUNTER DRINK CABINETS - REMOTE

BACK BAR REFRIGERATOR - STAINLESS STEEL DOORS AND FOLDED HANDLES

- Keeps contents at a cool 1°C in 32°C ambient temperatures
- Ensures maximum product visibility with interior vertical LED lighting
- Stainless steel double glazed, heated and toughened glass doors are self-closing and self-sealing to ensure ease of operation
- Available in 2-7 doors to suit every application
- Left hand hinged doors as standard
- Choice of either stainless steel or black internal and external finishes as standard
- Supplied with 4 adjustable shelves per door

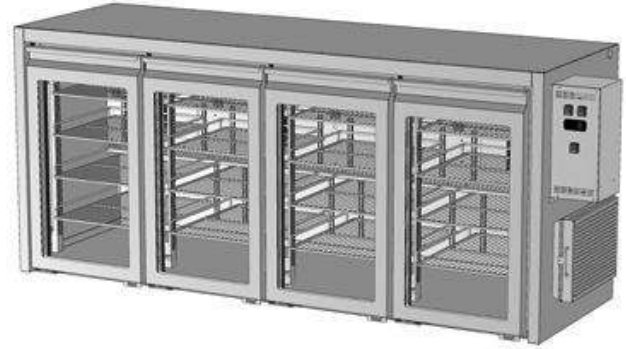

Stainless steel finish models

Description	Model	Dimensions	Electrical Rating	RRP ex GST
2 door model	CR.BB.UC2.T2.A.R.SSS.L.2	1450 x 700 x 960	300W, 1.2A 240V	\$10,965
3 door model	CR.BB.UC3.T2.A.R.SSS.L.2	1970 x 700 x 960	430W, 1.8A 240V	\$14,340
4 door model	CR.BB.UC4.T2.A.R.SSS.L.2	2490 x 700 x 960	576W, 2.4A 240V	\$17,725
5 door model	CR.BB.UC5.T2.A.R.SSS.L.2	3010 x 700 x 960	720W, 3A 240V	\$20,930
6 door model	CR.BB.UC6.T23.A.R.SSS.L.2	3530 x 700 x 960	865W, 3.6A 240V	\$24,270
7 door model	CR.BB.UC7.T2.A.R.SSS.L.2	4050 x 700 x 960	1010W, 4.2A 240V	\$27,465

Black finish models

Description	Model	Dimensions	Electrical Rating	RRP ex GST
2 door model	CR.BB.UC2.T2.A.R.BBB.L.2	1450 x 700 x 960	300W, 1.2A 240V	\$11,095
3 door model	CR.BB.UC3.T2.A.R.BBB.L.2	1970 x 700 x 960	430W, 1.8A 240V	\$14,555
4 door model	CR.BB.UC4.T2.A.R.BBB.L.2	2490 x 700 x 960	576W, 2.4A 240V	\$18,020
5 door model	CR.BB.UC5.T2.A.R.BBB.L.2	3010 x 700 x 960	720W, 3A 240V	\$21,315
6 door model	CR.BB.UC6.T2.A.R.BBB.L.2	3530 x 700 x 960	865W, 3.6A 240V	\$24,740
7 door model	CR.BB.UC7.T2.A.R.BBB.L.2	4050 x 700 x 960	1010W, 4.2A 240V	\$28,020

Customisation and variations on products listed above available upon request. See technical data sheet or ask your sales representative for more details. WA, NT & TAS - For orders in these states please add 5% transport surcharge to your purchase price

BACKBAR UNDER COUNTER DRINK CABINETS - REMOTE

BACK BAR REFRIGERATOR - STAINLESS STEEL DOORS AND RECESSED HANDLES

- Keeps contents at a cool 1°C in 32°C ambient temperatures
- Ensures maximum product visibility with interior vertical LED lighting
- Stainless steel double glazed, heated and toughened glass doors are self-closing and self-sealing to ensure ease of operation
- Available in 2-7 doors to suit every application
- Left hand hinged doors as standard
- Choice of either stainless steel or black internal and external finishes as standard
- Supplied with 4 adjustable shelves per door

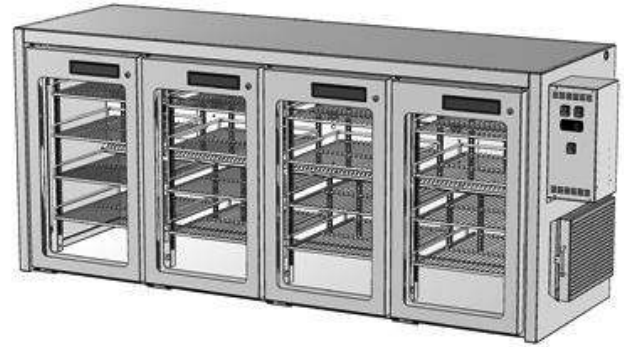

Stainless steel finish models

Description	Model	Dimensions	Electrical Rating	RRP ex GST
2 door model	CR.BB.UC2.T3.A.R.SSS.L.2	1450 x 700 x 960	300W, 1.2A 240V	\$10,725
3 door model	CR.BB.UC3.T3.A.R.SSS.L.2	1970 x 700 x 960	430W, 1.8A 240V	\$13,980
4 door model	CR.BB.UC4.T3.A.R.SSS.L.2	2490 x 700 x 960	576W, 2.4A 240V	\$17,245
5 door model	CR.BB.UC5.T3.A.R.SSS.L.2	3010 x 700 x 960	720W, 3A 240V	\$20,330
6 door model	CR.BB.UC6.T3.A.R.SSS.L.2	3530 x 700 x 960	865W, 3.6A 240V	\$23,495
7 door model	CR.BB.UC7.T3.A.R.SSS.L.2	4050 x 700 x 960	1010W, 4.2A 240V	\$26,625

Black finish models

Description	Model	Dimensions	Electrical Rating	RRP ex GST
2 door model	CR.BB.UC2.T3.A.R.BBB.L.2	1450 x 700 x 960	300W, 1.2A 240V	\$10,855
3 door model	CR.BB.UC3.T3.A.R.BBB.L.2	1970 x 700 x 960	430W, 1.8A 240V	\$14,200
4 door model	CR.BB.UC4.T3.A.R.BBB.L.2	2490 x 700 x 960	576W, 2.4A 240V	\$17,545
5 door model	CR.BB.UC5.T3.A.R.BBB.L.2	3010 x 700 x 960	720W, 3A 240V	\$20,720
6 door model	CR.BB.UC6.T3.A.R.BBB.L.2	3530 x 700 x 960	865W, 3.6A 240V	\$23,965
7 door model	CR.BB.UC7.T3.A.R.BBB.L.2	4050 x 700 x 960	1010W, 4.2A 240V	\$27,185

Customisation and variations on products listed above available upon request. See technical data sheet or ask your sales representative for more details. WA, NT & TAS - For orders in these states please add 5% transport surcharge to your purchase price

GLASS CHILLERS - REMOTE

1 DOOR GLASS CHILLERS

- Self-closing glass door with triple glazing
- Adjustable runners to hold 14" x 17" or 14" x 14" glass baskets. (Baskets not included)
- Full height, ergonomic door handle
- Full length, refrigeration system mounted on rear wall provides even, fan forced cooling and effective air temperature control
- Digital temperature controller for accurate and easy to read display
- Complete 304 grade stainless steel construction



Lift off lid model shown

Lift off lid model

Description	Model	Dimensions	Electrical Rating	RRP ex GST
1 Door, left hinged, lift off lid, control box on left	CR.GC.1D.L.LD	760 x 670 x 880	120W 0.5A 240V	\$5,020
1 Door, right hinged, lift off lid, control box on left	CR.GC.1D.L.RD	760 x 670 x 880	120W 0.5A 240V	\$5,020
1 Door, left hinged, lift off lid, control box on right	CR.GC.1D.R.LD	760 x 670 x 880	120W 0.5A 240V	\$5,020
1 Door, right hinged, lift off lid, control box on right	CR.GC.1D.R.RD	760 x 670 x 880	120W 0.5A 240V	\$5,020

Sliding lid model

Description	Model	Dimensions	Electrical Rating	RRP ex GST
1 Door, left hinged, sliding lid, control box on left	CR.GC.1D.L.LD.SL	760 x 670 x 880	120W 0.5A 240V	\$4,945
1 Door, right hinged, sliding lid, control box on left	CR.GC.1D.L.RD.SL	760 x 670 x 880	120W 0.5A 240V	\$4,945
1 Door, left hinged, sliding lid, control box on right	CR.GC.1D.R.LD.SL	760 x 670 x 880	120W 0.5A 240V	\$4,945
1 Door, right hinged, sliding lid, control box on right	CR.GC.1D.R.RD.SL	760 x 670 x 880	120W 0.5A 240V	\$4,945

Customisation and variations on products listed above available upon request. See technical data sheet or ask your sales representative for more details. WA, NT & TAS - For orders in these states please add 5% transport surcharge to your purchase price

GLASS CHILLERS - REMOTE

2 DOOR GLASS CHILLERS

- Self-closing glass door with triple glazing
- Adjustable runners to hold 14" x 17" or 14" x 14" glass baskets. (Baskets not included)
- Full height, ergonomic door handles
- Full length, refrigeration system mounted on rear wall provides even, fan forced cooling and effective air temperature control
- Digital temperature controller for accurate and easy to read display
- Complete 304 grade stainless steel construction

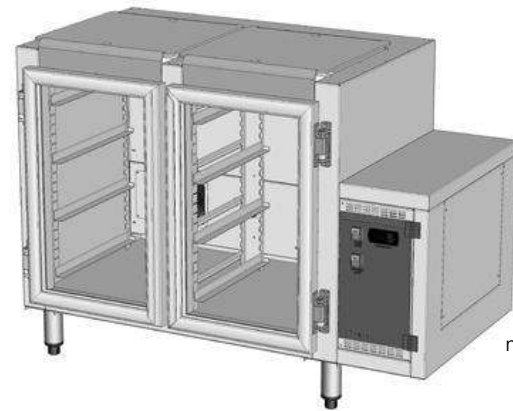

Lift off lid model shown

Lift off lid model

<i>Description</i>	<i>Model</i>	<i>Dimensions</i>	<i>Electrical Rating</i>	<i>RRP ex GST</i>
2 Door, lift off lid, control box on left	CR.GC.2D.L	1200 x 670 x 880	240W 1A 240V	\$6,520
2 Door, lift off lid, control box on right	CR.GC.2D.R	1200 x 670 x 880	240W 1A 240V	\$6,520

Sliding lid model

<i>Description</i>	<i>Model</i>	<i>Dimensions</i>	<i>Electrical Rating</i>	<i>RRP ex GST</i>
2 Door, sliding lid, control box on left	CR.GC.2D.L.SL	1200 x 670 x 880	240W 1A 240V	\$6,360
2 Door, sliding lid, control box on right	CR.GC.2D.R.SL	1200 x 670 x 880	240W 1A 240V	\$6,360

Customisation and variations on products listed above available upon request. See technical data sheet or ask your sales representative for more details. WA, NT & TAS - For orders in these states please add 5% transport surcharge to your purchase price

GLASS WASHER

EVO40ST GLASS WASHER

- Price efficient heavy duty glasswasher
- Double skin heavy duty door for added strength
- One touch operation with five wash cycles to achieve results
- Precise digital readouts of wash and rinse temperatures
- Diagnostic interface advises user if fault should occur
- Soft start to protect glassware of breakages
- Automatic self cleaning cycle
- Drain pump fitted for easy install
- Heavy duty S/S door hinges with no plastic
- Low water consumption
- Built in safety thermostop ensures correct rinse temperature
- Both detergent and rinse-aid dispensers included



<i>Description</i>	<i>Model</i>	<i>Dimensions</i>	<i>RRP ex GST</i>
High Performance Glass Washer	EVO40ST	480 x 505 x 750	\$3,150

GLASS WASHER

AT40ST GLASS WASHER

- Twin wash cycles for quick washing or lipstick removal
- Full double skin unit reduces heat and noise (47db)
- Cold rinse function reduces heat in glasses when busy
- Reinforced heavy duty S/S door hinges with no plastic
- Double skin heavy duty door for added strength
- One touch operation with twin wash cycles to achieve results
- Timer countdown shows user progress of wash cycles
- Precise digital readouts of wash and rinse temperatures
- Diagnostic interface advises user if fault should occur
- Soft start to protect glassware of breakages
- Self cleaning cycle
- Drain pump fitted for easy install
- Low water consumption
- Built in safety thermostat ensures correct rinse temperature
- Both detergent and rinse-aid dispensers included



<i>Description</i>	<i>Model</i>	<i>Dimensions</i>	<i>RRP ex GST</i>
Premium High Performance Glass Washer	AT40ST	510 x 515 x 745	\$3,700

TROLLEYS

TRAY LOWERATOR

- To be utilised for the transport and distribution of trays, dishwasher baskets and glasses in baskets
- Ideal for use in serving lines, tray makeup lines, or hot beverage service points
- Spring loaded lift mechanism, adjustable for different weight trays and baskets
- Includes pull/push handle
- Maximum load 100kg
- Stacking height at approximately 500mm
- Bottom storage surface with rubber bumpers
- Supplied with large 125mm diameter castors with brakes



<i>Description</i>	<i>Model</i>	<i>Dimensions</i>	<i>RRP ex GST</i>
Heavy duty stainless steel tray lowerator for holding service trays	CT.CTL.1	610 x 545 x 960	\$3,920
Heavy duty stainless steel tray lowerator for holding dishwasher baskets	CT.CTL.2	610 x 635 x 960	\$4,140

EXHAUST CANOPIES

EXHAUST CANOPIES

- The Culinaire range of kitchen exhaust hoods have been designed and manufactured to comply with Australian Standards
- The hoods are manufactured from 1.2mm thick Stainless Steel, 304 grade with No. 4 finish to be rigid and corrosion resistant
- A fully welded grease gutter (excluding condensate model) is integrated within the perimeter of the exhaust hood
- One (or more, depending on the length of the hood) sealed fluorescent lighting systems is supplied as standard
- The lights are accessible from inside the exhaust hood via a hinged, 6mm thick, safety glass cover
- The exhaust hoods are fitted with stainless steel baffle filters as standard
- Low profile filters (495mm x 254mm) allow for the overall hood height to be minimised
- Grease gutter plugs are located at each end of the wall-side of the exhaust hood gutter for periodic cleaning or for connection to a drain
- Condensate hoods are ideal for installations above commercial steamers, dishwashers and worktables
- All hoods (excluding condensate hoods) have the option of being manufactured in 1.2mm galvanised steel

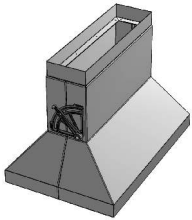
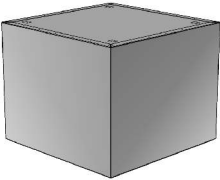
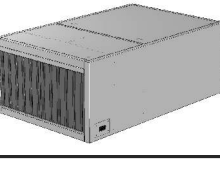
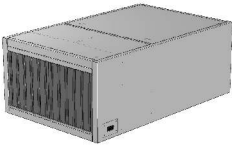
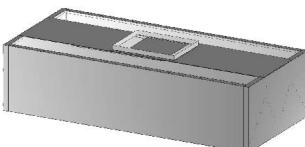
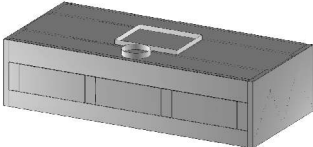
	Description	Model	RRP ex GST
	Condensate tapered hood	SPEH.CT.T1 .length.width.height.S	P.O.A
	Condensate hood Type 1 800mm high	SPEH.CB.T1.1000.1000.800.S	\$2,025
	Condensate hood Type 2 1050mm high	SPEH.CB.T2.1000.1000.1050.S	\$2,075
	Condensate recirculating hood	SPEH.CB.R.T1.1000.1600.600.S	\$4,300
	V Bank hood - Type 1 No make-up air		
	Stainless steel hood	SPEH.VB.T1 .length.1100.600.S	P.O.A
	Galvanised steel hood	SPEH.VB.T1 .length.1100.600.G	P.O.A
	V Bank hood - Type 1 With make-up air		
	Stainless steel hood	SPEH.VB.MA.T1 .length.1100.600.S	P.O.A
	Galvanised steel hood	SPEH.VB.MA.T1 .length.1100.600.G	P.O.A

Customisation and variations on products listed above available upon request. See technical data sheet or ask your sales representative for more details. Packed ex works Brisbane - Freight not included

EXHAUST CANOPIES

EXHAUST CANOPIES

- The Culinaire range of kitchen exhaust hoods have been designed and manufactured to comply with Australian Standards
- The hoods are manufactured from 1.2mm thick Stainless Steel, 304 grade with No. 4 finish to be rigid and corrosion resistant
- A fully welded grease gutter is integrated within the perimeter of the exhaust hood
- One (or more, depending on the length of the hood) sealed fluorescent lighting systems is supplied as standard
- The lights are accessible from inside the exhaust hood via a hinged, 6mm thick, safety glass cover
- The exhaust hoods are fitted with stainless steel baffle filters as standard
- The size of the filters (495mm x 495mm) reduces the need for frequent cleaning, yet allows them to fit into most dishwashers
- Grease gutter plugs are located at each end of the wall-side of the exhaust hood gutter for periodic cleaning or for connection to a drain
- All hoods have the option of being manufactured in 1.2mm galvanised steel

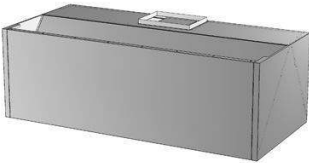
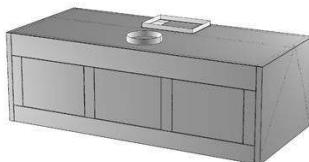
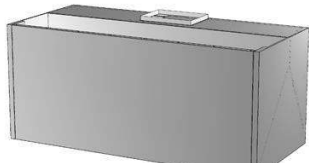
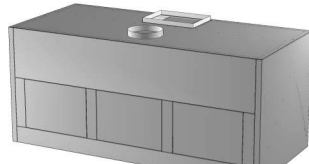

	<i>Description</i>	<i>Model</i>	<i>RRP ex GST</i>
	Box hood - Type 1 No make-up air		
	1100 wide stainless steel hood	SPEH.BH.T1.length.1100.800.S	P.O.A
	1100 wide galvanised steel hood	SPEH.BH.T1.length.1100.800.G	P.O.A
	Box hood - Type 1 With make-up air		
	1100 wide stainless steel hood	SPEH.BH.MA.T1.length.1100.800.S	P.O.A
	1100 wide galvanised steel hood	SPEH.BH.MA.T1.length.1100.800.G	P.O.A
	Box hood - Type 2 No make-up air		
	1200 wide stainless steel hood	SPEH.BH.T2.length.1200.1050.S	P.O.A
	1200 wide galvanised steel hood	SPEH.BH.T2.length.1200.1050.G	P.O.A
	Box hood - Type 2 With make-up air		
	1200 wide stainless steel hood	SPEH.BH.MA.T2.length.1200.1050.S	P.O.A
	1200 wide galvanised steel hood	SPEH.BH.MA.T2.length.1200.1050.G	P.O.A

Customisation and variations on products listed above available upon request. See technical data sheet or ask your sales representative for more details. Packed ex works Brisbane - Freight not included

SERVICE WALLS

FREE STANDING SERVICE WALLS

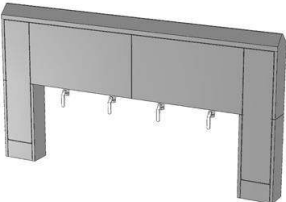
- Free standing spine walls and utility distribution system walls allow cooking equipment to sit hard back, with no visible void behind the equipment, yet still allowing enough space for all external and flexible connections
- Formed channel construction for stability
- The service wall is designed to allow hydraulic, gas and electrical mains to be run with ease through risers, from penetration in the slab
- To minimise drilling on-site and allow easy installation, all internal stiffeners have 25mm diameter holes provided
- Risers can be provided with recessed panels to the end to accommodate the gas shut-off valve or electrical isolator switches (to be specified when ordering)
- All free standing models available with and without services

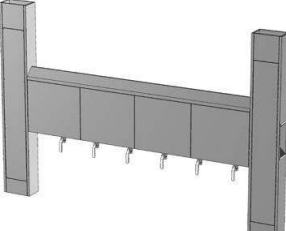
	<i>Description</i>	<i>Model</i>	<i>RRP ex GST</i>
	Free standing no service riser spine wall	CU.SWFS.NSR.T1x.length	P.O.A
	Free standing no service riser utility distribution system	CU.SWFS.NSR.T2x.length	P.O.A
	Free standing single riser spine wall	CU.SWFS.SSR.T1x.H.length	P.O.A
	Free standing single riser utility distribution system	CU.SWFS.SSR.T2x.H.length	P.O.A
	Free standing dual riser spine wall	CU.SWFS.DSR.T1x.H.length	P.O.A
	Free standing dual riser utility distribution system	CU.SWFS.DSR.T2x.H.length	P.O.A

Customisation and variations on products listed above available upon request. See technical data sheet or ask your sales representative for more details. WA, NT & TAS - For orders in these states please add 5% transport surcharge to your purchase price

SERVICE WALLS

WALL MOUNTED SERVICE WALL

- Wall mounted utility distribution system walls allow cooking equipment to sit hard back, with no visible void behind the equipment, yet still allowing enough space for all external and flexible connections
- Formed channel construction for stability
- The service wall is designed to allow hydraulic, gas and electrical mains to be run with ease from the ceiling space through pre-drilled holes in the top channel
- To minimise drilling on-site and allow easy installation, all internal stiffeners have 25mm diameter holes provided
- Risers can be provided with recessed panels to the end to accommodate the gas shut off valve or electrical isolator switches, specify when ordering

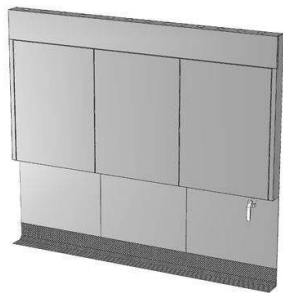

<i>Description</i>	<i>Model</i>	<i>RRP ex GST</i>
Wall mounted service wall	CU.WM.length	P.O.A

Customisation and variations on products listed above available upon request. See technical data sheet or ask your sales representative for more details. WA, NT & TAS - For orders in these states please add 5% transport surcharge to your purchase price